

Article number: 2310309477ESD

Description: E+G Antistatic base for levelling elements
LV.A-100-14-AS-M14X68-ESD-C

Measures

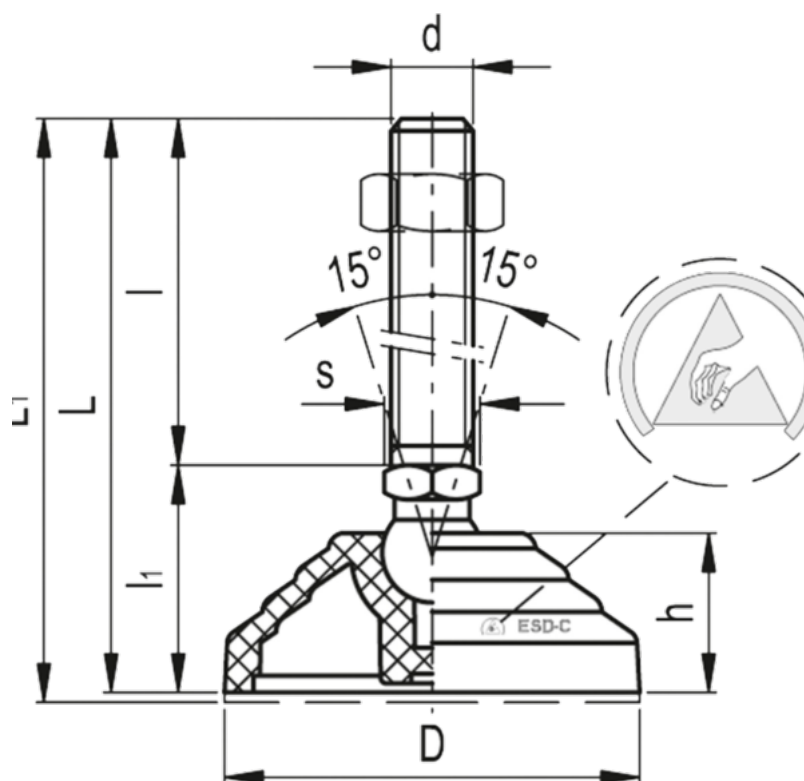

Articulation = 14	Max load = 18000
D = 100	s = 14
d = M14	Weight in (g) = 204
h = 24	
l = 68	
L1 = 33	
L = 101	
L1 = 104	